



OSLO EXTENDING TABLE

Shown here in Medium Oak and removable central extending leaf.

H74 W380/440 D120 cm
Seats 12 to 16

The Oslo Extending Table is also offered in the following sizes:

H74 W320/380 D120 cm
Seats 10 to 14

H74 W260/320 D120 cm
Seats 8 to 12

As with all Fiona McDonald Bespoke pieces, the Oslo Extending Table is made to order. We can easily adapt and customise our designs, not only in measurement but also material, detail and finish.

Handmade in England.

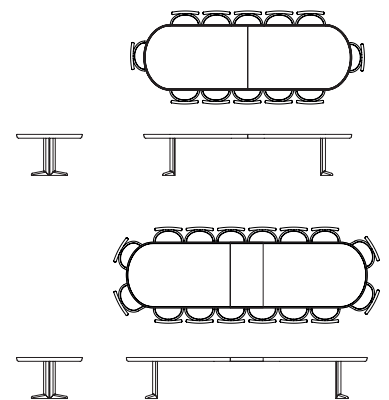



TIMBERS AND FINISHES

Standard timber finishes shown. Alternative timbers and finishes are available, please enquire for more details.



Mahogany
Light French Polish



Limed Oak
Light Lacquer

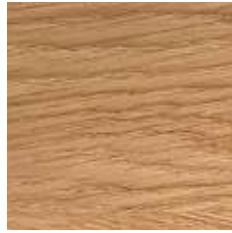

Oak
Light Lacquer

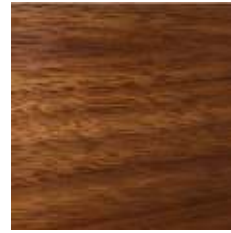

Walnut
Light French Polish



Walnut
Light Lacquer



Mahogany
Medium French Polish



Limed Oak
Medium Lacquer



Oak
Medium Lacquer



Walnut
Medium French Polish

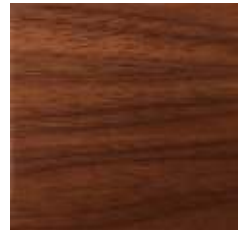

Walnut
Medium Lacquer



Limed Oak
Dark Lacquer

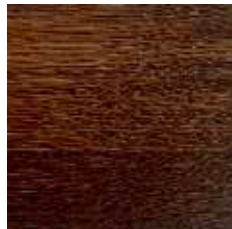

Oak
Dark Lacquer

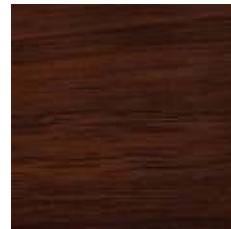

Walnut
Dark French Polish



Walnut
Dark Lacquer

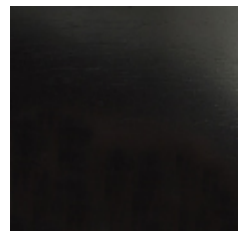

Ebonised Walnut



CARE AND MAINTENANCE

Please note that all the instructions below are suggested methods of care and maintenance. We are not responsible for any damage incurred whilst cleaning. Always try a cleaning method on a hidden area first.

Marble and Stone

Marble and stone are natural materials and should be treated as such. If required, seal upon installation and repeat every 6 months or so. Please be aware that spills will penetrate even sealed marble and stone and stain after a couple of hours. Use pH neutral cleaners only.

PU Lacquer Finishes

For regular maintenance, dust lightly with a soft cloth following the timber's grain. Most blemishes can be wiped off gently with a soft dampened cloth, again following the timber's grain. Do not rub with abrasive materials or use detergents or solvents.

Do not use furniture wax and/or spray polishes as these will affect the finish.

Anything with a rough or abrasive underside, for example cups or plates, will scratch the finish, however slightly. Always use soft base coasters.

Avoid direct sunlight and high temperatures as this will compromise the finish.

Paint Lacquer Finishes

For regular maintenance, dust lightly with a soft cloth. Most blemishes can be wiped off gently with a soft dampened cloth. Do not rub with abrasive materials or use detergents or solvents.

Do not use furniture wax and/or spray polishes as these will affect the finish.

Anything with a rough or abrasive underside, for example cups or plates, will scratch the finish, however slightly. Always use soft base coasters.

Avoid direct sunlight and high temperatures as this will compromise the finish.

French Polish Finishes

For regular maintenance, dust lightly with a soft dry cloth following the timber's grain. Do not use a dampened cloth. Wipe up any spillages quickly as liquids compromise French polish. Do not rub with abrasive materials or use detergents or solvents.

Clear wax can be used which will add a little shine. The only products to use are pure, clear furniture waxes by quality brands. It is important not to use waxes with cleaning agents or turpentine. The wax should be applied sparingly with a soft cloth following the timber's grain and wiped off quickly before it dries. Application will be easier if the wax is warm. Buff to shine using a clean dry soft cloth, again following the timber's grain.

Do not use spray polishes as these will affect the finish.

Anything with a rough or abrasive underside, for example cups or plates, will scratch the finish, however slightly. Always use soft base coasters.

Avoid direct sunlight and high temperature as this will compromise the finish.

Unlacquered Metal Finishes

For regular maintenance, dust lightly with a soft dry cloth. Most blemishes can be wiped off gently with a soft dampened cloth. Do not scrub with abrasive materials or use detergents, solvents or metal polishes.

In the case of bad soiling, a very mild soap solution can be used, but once the dirt has lifted, wipe off immediately. Care must be taken not to leave the surface wet for more than a few moments.

Clear wax can be used to leave a protective coat and add a little shine. The only products to use are pure, clear furniture waxes by quality brands or their aerosol equivalents. It is important not to use waxes with added cleaning agents or turpentine. The wax should be applied sparingly with a soft cloth and wiped off quickly before it dries. Application will be easier if the wax is warm.

Glass and Mirror

For regular maintenance, the surface should be dusted with a soft dry cloth. Most blemishes can be removed using a dampened cloth and/or by the use of a quality brand glass cleaner.